

### 1. PART NO. EXPRESSION :

**SCI1008S - 5N6KF**

(a) (b) (c) (d) (e)(f)

(a) Series code

(b) Dimension code

(c) Type code : S ( Standard )

(d) Inductance code : 5N6 = 5.6nH

(e) Tolerance code : G = ±2%, J = ±5%, K = ±10%

(f) F : RoHS Compliant

### 2. CONFIGURATION & DIMENSIONS :

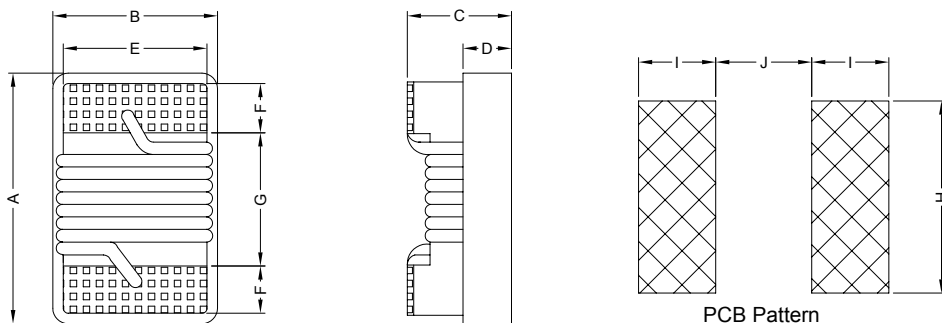

PCB Pattern

Unit:m/m

A	B	C	D	E	F	G	H	I	J
2.92 Max.	2.79 Max.	2.03 Max.	0.65 Ref.	2.03 Ref.	0.51 Ref.	1.52 Ref.	2.54 Ref.	1.02 Ref.	1.27 Ref.

### 3. SCHEMATIC :

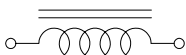

### 4. MATERIALS :

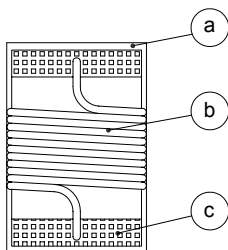

(a) Core : Ceramic U core

(b) Wire : Enamelled Copper Wire

(c) Terminal Metallization : Ag + Ni + Au



**RoHS Compliant**

NOTE : Specifications subject to change without notice. Please check our website for latest information.

22.06.2010



**SUPERWORLD ELECTRONICS (S) PTE LTD**

## 5. GENERAL SPECIFICATION :

- a) Storage temp. : -25°C to +80°C
- b) Operating temp. : -40°C to +125°C
- c) Temperature rise : 40°C Max.
- d) Rated current : Base on temp. rise &  $\Delta L/L0A=10\%$  Max.
- e) Resistance to solder heat : 260°C.10sec

## 6. ELECTRICAL CHARACTERISTICS :

Part No.	Tolerance Available	L ( nH )	Test Freq ( MHz )	Q Min.	Q Test Freq ( MHz )	SRF ( MHz ) Min.	DCR ( $\Omega$ ) Max.	IDC ( mA ) Max.
SCI1008S-5N6□F	K, J	5.6	50	50	1500	4000	0.150	1000
SCI1008S-10N□F	K, J, G	10	50	50	500	4100	0.080	1000
SCI1008S-12N□F	K, J, G	12	50	50	500	3300	0.090	1000
SCI1008S-15N□F	K, J, G	15	50	50	500	2500	0.110	1000
SCI1008S-18N□F	K, J, G	18	50	50	350	2400	0.120	1000
SCI1008S-22N□F	K, J, G	22	50	55	350	2400	0.120	1000
SCI1008S-24N□F	K, J, G	24	50	55	350	1900	0.120	1000
SCI1008S-27N□F	K, J, G	27	50	55	350	1600	0.130	1000
SCI1008S-33N□F	K, J, G	33	50	60	350	1600	0.140	1000
SCI1008S-39N□F	K, J, G	39	50	60	350	1500	0.150	1000
SCI1008S-47N□F	K, J, G	47	50	65	350	1500	0.160	1000
SCI1008S-56N□F	K, J, G	56	50	65	350	1300	0.180	1000
SCI1008S-62N□F	K, J, G	62	50	65	350	1250	0.200	1000
SCI1008S-68N□F	K, J, G	68	50	65	350	1300	0.200	1000
SCI1008S-75N□F	K, J, G	75	50	60	350	1100	0.210	1000
SCI1008S-82N□F	K, J, G	82	50	60	350	1000	0.220	1000
SCI1008S-R10□F	K, J, G	100	25	60	350	1000	0.560	650
SCI1008S-R12□F	K, J, G	120	25	60	350	950	0.630	650
SCI1008S-R15□F	K, J, G	150	25	45	100	850	0.700	580
SCI1008S-R18□F	K, J, G	180	25	45	100	750	0.770	620
SCI1008S-R22□F	K, J, G	220	25	45	100	700	0.840	500
SCI1008S-R24□F	K, J, G	240	25	45	100	650	0.880	500
SCI1008S-R27□F	K, J, G	270	25	45	100	600	0.910	500



**RoHS Compliant**

NOTE : Specifications subject to change without notice. Please check our website for latest information.

22.06.2010



**SUPERWORLD ELECTRONICS (S) PTE LTD**

## 6. ELECTRICAL CHARACTERISTICS :

Part No.	Tolerance Available	L ( nH )	Test Freq ( MHz )	Q Min.	Q Test Freq ( MHz )	SRF ( MHz ) Min.	DCR ( $\Omega$ ) Max.	IDC ( mA ) Max.
SCI1008S-R30□F	K, J, G	300	25	45	100	585	1.00	450
SCI1008S-R33□F	K, J, G	330	25	45	100	570	1.05	450
SCI1008S-R36□F	K, J, G	360	25	45	100	530	1.10	470
SCI1008S-R39□F	K, J, G	390	25	45	100	500	1.12	470
SCI1008S-R43□F	K, J, G	430	25	45	100	480	1.15	470
SCI1008S-R47□F	K, J, G	470	25	45	100	450	1.19	470
SCI1008S-R56□F	K, J, G	560	25	45	100	415	1.33	400
SCI1008S-R62□F	K, J, G	620	25	45	100	375	1.40	300
SCI1008S-R68□F	K, J, G	680	25	45	100	375	1.47	400
SCI1008S-R75□F	K, J, G	750	25	45	100	360	1.54	360
SCI1008S-R82□F	K, J, G	820	25	45	100	350	1.61	400
SCI1008S-R91□F	K, J, G	910	25	35	50	320	1.68	380
SCI1008S-1R0□F	K, J, G	1000	25	35	50	290	1.75	370
SCI1008S-1R2□F	K, J, G	1200	7.96	35	50	250	2.00	310
SCI1008S-1R5□F	K, J, G	1500	7.96	28	50	200	2.30	330
SCI1008S-1R8□F	K, J, G	1800	7.96	28	50	160	2.60	300
SCI1008S-2R2□F	K, J, G	2200	7.96	28	50	160	2.80	280
SCI1008S-2R7□F	K, J, G	2700	7.96	22	25.2	140	3.20	290
SCI1008S-3R3□F	K, J, G	3300	7.96	22	25.2	110	3.40	290
SCI1008S-3R9□F	K, J, G	3900	7.96	20	25.2	100	3.60	260
SCI1008S-4R7□F	K, J, G	4700	7.96	20	25.2	90	4.00	260
SCI1008S-5R6□F	K, J, G	5600	7.96	16	7.96	20	4.00	240
SCI1008S-6R8□F	K, J, G	6800	7.96	15	7.96	40	4.90	200
SCI1008S-8R2□F	K, J, G	8200	7.96	15	7.96	25	6.00	170
SCI1008S-103□F	K, J, G	10000	2.52	15	7.96	20	9.00	150
SCI1008S-123□F	K, J, G	12000	2.52	15	7.96	18	10.5	130
SCI1008S-153□F	K, J, G	15000	2.52	15	7.96	15	11.5	120

Inductance tolerance :

- : G :  $\pm 2\%$
- J :  $\pm 5\%$
- K :  $\pm 10\%$



**RoHS Compliant**

NOTE : Specifications subject to change without notice. Please check our website for latest information.

22.06.2010



**SUPERWORLD ELECTRONICS (S) PTE LTD**

### 7. PACKAGING INFORMATION :

Reel Configuration :

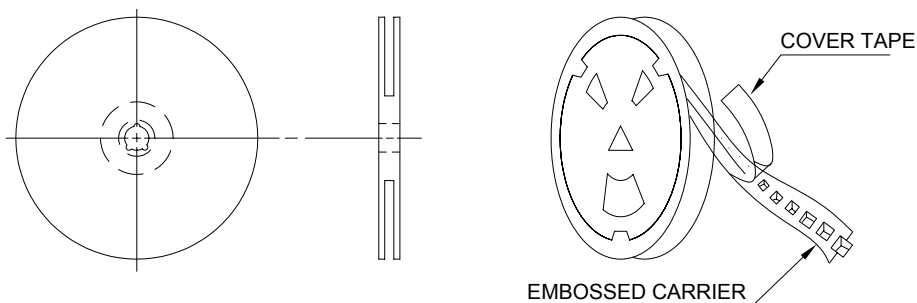

Paper Tape :

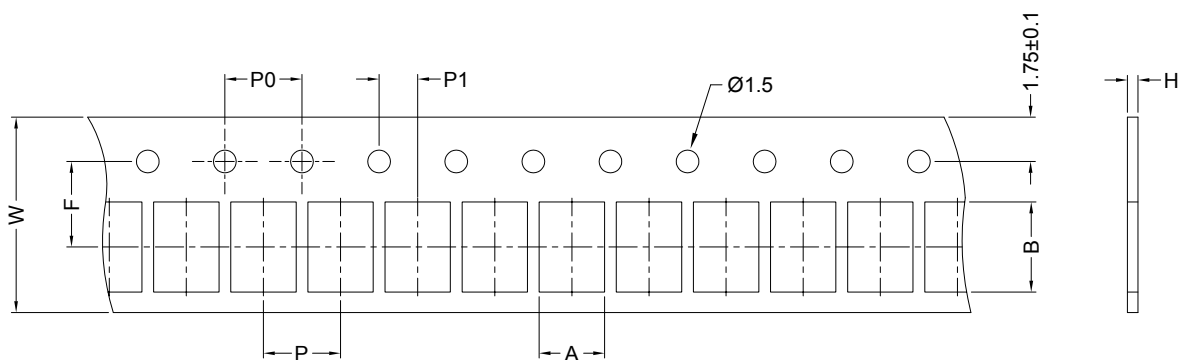

Dimension (unit: mm)

Series	A	B	H	F	P	P0	P1	W	Qty
SCI0402S	0.72	1.19	0.60	3.50	4.00	4.00	2.00	8.00	4000pcs / reel
SCI0603S	1.35	1.95	0.95	3.50	4.00	4.00	2.00	8.00	4000pcs / reel



**RoHS Compliant**

NOTE : Specifications subject to change without notice. Please check our website for latest information.

22.06.2010



**SUPERWORLD ELECTRONICS (S) PTE LTD**

Embossed Carrier Tape :

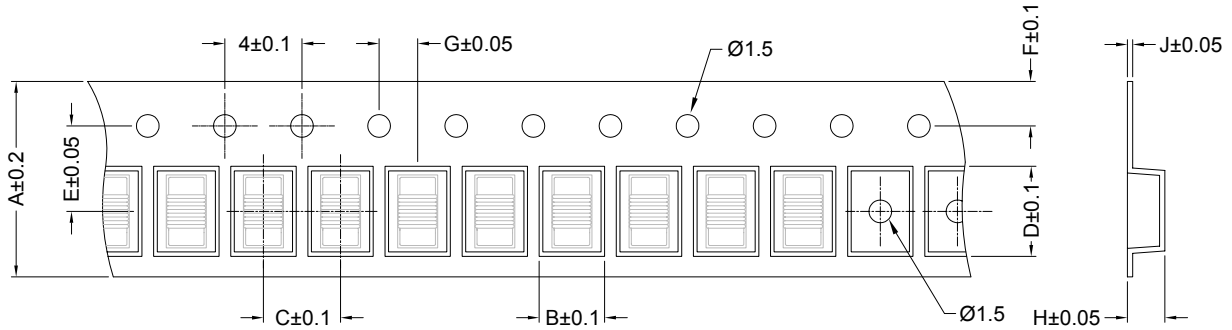

Dimension (unit: mm)

Series	A	B	C	D	E	F	G	H	J	Qty
SCI0805S	8	1.85	4	2.30	3.5	1.75	2	1.45	0.23	2000pcs / reel
SCI0805LP	8	1.80	4	2.30	3.5	1.75	2	0.90	0.23	2000pcs / reel
SCI0805HQ	8	1.85	4	2.30	3.5	1.75	2	1.45	0.23	2000pcs / reel
SCI1008S	8	2.70	4	2.80	3.5	1.75	2	2.00	0.23	2000pcs / reel
SCI1008LP	8	2.70	4	2.80	3.5	1.75	2	1.50	0.23	2000pcs / reel
SCI1008HQ	8	2.70	4	2.80	3.5	1.75	2	2.00	0.23	2000pcs / reel

Leader/Trailer Tape :

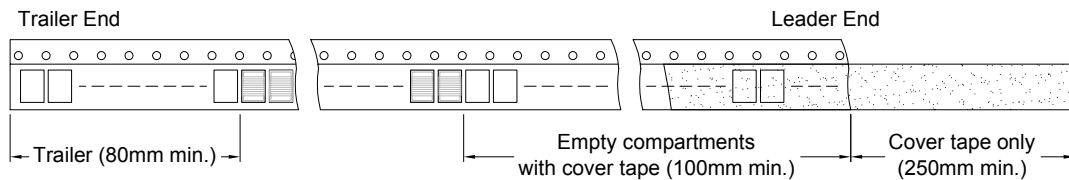

Peel-off Force :

Peel-off force should be in the range of 0.1N~0.7N at a peel-off speed of 300±10mm/min.

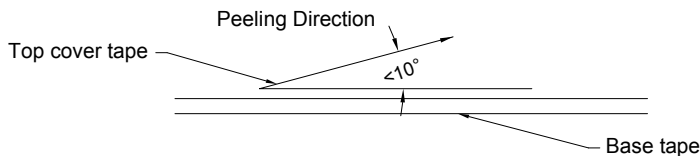

**RoHS Compliant**

NOTE : Specifications subject to change without notice. Please check our website for latest information.

22.06.2010



**SUPERWORLD ELECTRONICS (S) PTE LTD**

### 8. ENVIRONMENTAL CHARACTERISTICS :

Electrical Performance Test :

ITEM		SPECIFICATION	TEST CONDITIONS / TEST METHODS
1	Inductance	Refer to Electrical Characteristics List	HP4291B
2	Q		HP4291B
3	SRF		HP8753D
4	DC Resistance Rdc		Mico-Ohmmeter (GOM-801G)
5	Rated Current IDC		The device should be REFLOW soldered (230±5°C for 10 seconds) to a tinned copper subs rate. A dynamiter
6	Over Load Test	After test, inductors shall have no evidence of electrical and mechanical damage	Applied 2 times of rated allowed DC current to inductor for a period of 5 minute.
7	Withstanding Voltage Test	After test, inductors shall have no evidence of electrical and mechanical damage	AC voltage of 500VAC applied between inductors terminal and case for 1 minute.
8	Insulation Resistance Test	1000 MOhm min.	100VDC applied between inductor terminal and case



**RoHS Compliant**

NOTE : Specifications subject to change without notice. Please check our website for latest information.

22.06.2010



**SUPERWORLD ELECTRONICS (S) PTE LTD**

Mechanical Performance Test :

ITEM		SPECIFICATION	TEST CONDITIONS / TEST METHODS
1	Vibration	Appearance : No damage L change : within $\pm 5\%$ Q change : within $\pm 10\%$	Test device shall be soldered on the substrate Oscillation Frequency : 10 to 55 to 10Hz for 1 min. Amplitude : 1.5mm Time : 2hrs for each axis (X, Y, Z), total 6hrs.
2	Resistance to Soldering Heat	Appearance : No damage L change : within $\pm 5\%$ Q change : within $\pm 10\%$	Pre-heating : 150°C, 1 min Solder Composition : Sn/Pb=63/67 Solder Temperature : 230 $\pm$ 5°C Immersion Time : 20 $\pm$ 2sec Solder Temperature : 260 $\pm$ 5°C Immersion Time : 5 $\pm$ 2sec
3	Component Adhesion (Push Test)	1 lbs. For 0402 2 lbs. For 0603 3 lbs. For the rest	The device should be REFLOW soldered (230 $\pm$ 5°C for 10 seconds) to a tinned copper subs rate. A dynamiter force gauge should be applied to the side of the component. The device must withstand a minimum force of 2 or 4 pounds without a failure of the termination attached to component.
3	Component Adhesion (Push Test)	The electrodes shall be at least 90% covered with new solder coating.	Pre-heating : 150°C, 1min Solder Composition : Sn/Pb=63/67 Solder Temperature : 230 $\pm$ 5°C Immersion Time : 4 $\pm$ 1sec
4	Drop Test	After test, the chip inductor don't fell of broke on the P.C.Board	Drop 1 time for each face and 1 time for each corner. Total drop 10 times. Drop Height : 100cm Drop Weight : 125g
5	Solderability Test	The terminal should at least be 90% covered with solder	after fluxing (alpha 100 or equiv), inductor shall be dipped in a melted solder bath at 232 $\pm$ 5°C for 5 seconds.
6	Resistance to solvent test	There shall be no case of deformation change in appearance of obliteration of marking	MIL-STD202F, METHOD 215D



**RoHS Compliant**

NOTE : Specifications subject to change without notice. Please check our website for latest information.

22.06.2010



**SUPERWORLD ELECTRONICS (S) PTE LTD**

PG. 7

Climatic Test :

ITEM		SPECIFICATION	TEST CONDITIONS / TEST METHODS															
1	Temperature Characteristics	Appearance : No damage L change : within $\pm 10\%$ Q change : within $\pm 20\%$	-40°C ~ +125°C															
2	Humidity Resistance		Temperature : 40 $\pm$ 2°C Relative Humidity : 90~95% Time : 96hrs $\pm$ 2hrs Measured after exposure in the room condition for 2hrs															
3	Low Temperature Storage Test		Temperature : -40 $\pm$ 2°C Time : 48 $\pm$ 2hrs Inductors are to be tested after 1 hour at room temperature.															
4	Thermal Shock Test		One cycle : <table border="1" style="margin-left: 20px;"> <thead> <tr> <th>Step</th> <th>Temperature (°C)</th> <th>Time (min)</th> </tr> </thead> <tbody> <tr> <td>1</td> <td>-25<math>\pm</math>3</td> <td>30</td> </tr> <tr> <td>2</td> <td>25<math>\pm</math>2</td> <td>15</td> </tr> <tr> <td>3</td> <td>85<math>\pm</math>3</td> <td>30</td> </tr> <tr> <td>4</td> <td>25<math>\pm</math>2</td> <td>15</td> </tr> </tbody> </table> Total : 5 cycles	Step	Temperature (°C)	Time (min)	1	-25 $\pm$ 3	30	2	25 $\pm$ 2	15	3	85 $\pm$ 3	30	4	25 $\pm$ 2	15
Step	Temperature (°C)		Time (min)															
1	-25 $\pm$ 3		30															
2	25 $\pm$ 2		15															
3	85 $\pm$ 3	30																
4	25 $\pm$ 2	15																
5	High Temperature Storage Test	Temperature : 125 $\pm$ 2°C Time : 48 $\pm$ 2hrs Load : Allowed DC current																
6	High Temperature Load Life Test	Temperature : 85 $\pm$ 2°C Time : 1000 $\pm$ 12hrs Load : Allowed DC current																
7	Humidity Load Life	Temperature : 40 $\pm$ 2°C Relative Humidity : 90~95% Time : 1000 $\pm$ 12hrs Load : Allowed DC current																



**RoHS Compliant**

NOTE : Specifications subject to change without notice. Please check our website for latest information.

22.06.2010



**SUPERWORLD ELECTRONICS (S) PTE LTD**